

MSTB 2,5/11-ST-5,08

Order No.: 1757103

The figure shows a 10-position version of the product

<http://eshop.phoenixcontact.de/phoenix/treeViewClick.do?UID=1757103>

Plug component, nominal current: 12 A, rated voltage: 250 V, pitch:
5.08 mm, no. of positions: 11, type of connection: Screw connection

Commercial data

EAN	4017918029630
Pack	50 Pcs.
Customs tariff	85366990
Weight/Piece	0.0193 KG
Catalog page information	Page 174 (CC-2007)

Product notes

WEEE/RoHS-compliant since:
01/01/2003



<http://www.download.phoenixcontact.com>
Please note that the data given here has been taken from the online catalog. For comprehensive information and data, please refer to the user documentation. The General Terms and Conditions of Use apply to Internet downloads.

Technical data

Dimensions / positions

Pitch	5.08 mm
Dimension a	50.8 mm
Number of positions	11
Screw thread	M 3
Tightening torque, min	0.5 Nm

Technical data

Insulating material group	I
Rated surge voltage (III/3)	4 kV
Rated surge voltage (III/2)	4 kV
Rated surge voltage (II/2)	4 kV
Rated voltage (III/2)	320 V
Rated voltage (II/2)	630 V
Connection in acc. with standard	EN-VDE
Nominal current I_N	12 A
Nominal voltage U_N	250 V
Nominal cross section	2.5 mm ²
Maximum load current	12 A (with 2.5 mm ² conductor cross section)
Insulating material	PA
Inflammability class acc. to UL 94	V0
Internal cylindrical gage	A3
Stripping length	7 mm

Connection data

Conductor cross section solid min.	0.2 mm ²
Conductor cross section solid max.	2.5 mm ²
Conductor cross section stranded min.	0.2 mm ²
Conductor cross section stranded max.	2.5 mm ²
Conductor cross section stranded, with ferrule without plastic sleeve min.	0.25 mm ²
Conductor cross section stranded, with ferrule without plastic sleeve max.	2.5 mm ²
Conductor cross section stranded, with ferrule with plastic sleeve min.	0.25 mm ²
Conductor cross section stranded, with ferrule with plastic sleeve max.	2.5 mm ²
Conductor cross section AWG/kcmil min.	24
Conductor cross section AWG/kcmil max	12
2 conductors with same cross section, solid min.	0.2 mm ²
2 conductors with same cross section, solid max.	1 mm ²
2 conductors with same cross section, stranded min.	0.2 mm ²

2 conductors with same cross section, stranded max.	1.5 mm ²
2 conductors with same cross section, stranded, ferrules without plastic sleeve, min.	0.25 mm ²
2 conductors with same cross section, stranded, ferrules without plastic sleeve, max.	1 mm ²
2 conductors with same cross section, stranded, TWIN ferrules with plastic sleeve, min.	0.5 mm ²
2 conductors with same cross section, stranded, TWIN ferrules with plastic sleeve, max.	1.5 mm ²

Certificates / Approvals



CSA

Nominal voltage U _N	300 V
Nominal current I _N	10 A
AWG/kcmil	28-12

CUL

Nominal voltage U _N	300 V
Nominal current I _N	10 A
AWG/kcmil	30-12

UL

Nominal voltage U _N	300 V
Nominal current I _N	10 A
AWG/kcmil	30-12
Certification	CB, CSA, CUL, GOST, UL, VDE-PZI

Accessories

Item	Designation	Description
Bridges		
1733172	EBP 3- 5	Insertion bridge, fully insulated, for plug connectors with 5.0 or 5.08 mm pitch, no. of positions: 3
1733185	EBP 4- 5	Insertion bridge, fully insulated, for plug connectors with 5.0 or 5.08 mm pitch, no. of positions: 4

1733198	EBP 5- 5	Insertion bridge, fully insulated, for plug connectors with 5.0 or 5.08 mm pitch, no. of positions: 5
1733208	EBP 6- 5	Insertion bridge, fully insulated, for plug connectors with 5.0 or 5.08 mm pitch, no. of positions: 6

General

1733169	EBP 2- 5	Insertion bridge, fully insulated, for plug connectors with 5.0 or 5.08 mm pitch, no. of positions: 2
1783805	KGS-MSTB 2,5/11	Cable housing, for cable diameters of 6 - 13.5 mm, marker strips and transparent label carrier are included, color: green, no. of positions: 11

Marking

1051993	B-STIFT	Marker pen, for manual labeling of unprinted Zack strips, smear-proof and waterproof, line thickness 0.5 mm
0805108	SK 5,08/2,8:SO	Marker card, special printing, self-adhesive, labeled acc. to customer requirements, 14 identical marker strips per card, max. 25-position labeling per strip, color: White
0804293	SK 5,08/3,8:FORTL.ZAHLEN	Marker card, printed horizontally, self-adhesive, 12 identical decades marked 1-10, 11-20 etc. up to 91-(99)100, sufficient for 120 terminal blocks
0803883	SK U/2,8 WH:UNBEDRUCKT	Unprinted marker cards, DIN A4 format, pitch as desired, self-adhesive, with 50 stamped marker strips, 185 mm strip length, can be labeled with the CMS system or manually with the M-PEN

Plug/Adapter

1734634	CP-MSTB	Coding profile, is inserted into the slot on the plug or inverted header, red insulating material
---------	---------	---

Tools

1205053	SZS 0,6X3,5	Screwdriver, bladed, matches all screw terminal blocks up to 4.0 mm ² connection cross section, blade: 0.6 x 3.5 mm, without VDE approval
---------	-------------	--

Additional products

Item	Designation	Description
General		
1873443	FKIC 2,5/11-ST-5,08	Plug, nominal current: 12 A, rated voltage: 320 V, pitch: 5.08 mm, number of positions: 11, connection method: Spring-cage connection
1823930	ICC 2,5/11-STZ-5,08	Plug component, nominal current: 12 A, rated voltage: 250 V, pitch: 5.08 mm, no. of positions: 11, type of connection: Crimp connection

1762460	MDSTB 2,5/11-G1-5,08	Header, nominal current: 10 A, rated voltage: 250 V, pitch: 5.08 mm, no. of positions: 11, mounting: Soldering
1762596	MDSTBV 2,5/11-G1-5,08	Header, nominal current: 10 A, rated voltage: 250 V, pitch: 5.08 mm, no. of positions: 11, mounting: Soldering
1770805	MSTB 2,5/11-G-5,08-LA	Header, nominal current: 12 A, rated voltage: 250 V, pitch: 5.08 mm, no. of positions: 11, mounting: Soldering
1757336	MSTBA 2,5/11-G-5,08	Header, nominal current: 12 A, rated voltage: 250 V, pitch: 5.08 mm, no. of positions: 11, mounting: Soldering
1768037	MSTBA 2,5/11-G-5,08-LA	Header, nominal current: 12 A, rated voltage: 250 V, pitch: 5.08 mm, no. of positions: 11, mounting: Soldering
1788813	MSTBVK 2,5/11-G-5,08	Header, nominal current: 12 A, rated voltage: 320 V, pitch: 5.08 mm, no. of positions: 11, mounting: Mounting rail
1788622	MVSTBU 2,5/11-GB-5,08	Header, nominal current: 12 A, rated voltage: 320 V, pitch: 5.08 mm, no. of positions: 11, mounting: Direct mounting
1769557	SMSTB 2,5/11-G-5,08	Header, nominal current: 12 A, rated voltage: 250 V, pitch: 5.08 mm, no. of positions: 11, mounting: Soldering
1767465	SMSTBA 2,5/11-G-5,08	Header, nominal current: 12 A, rated voltage: 250 V, pitch: 5.08 mm, no. of positions: 11, mounting: Soldering
3002034	UK 3-MSTB-5,08	Modular terminal blocks with plug entry, cross section: 0.2 - 2.5 mm ² , AWG: 30 - 12, width: 5.1 mm, color: gray
3002076	UK 3-MVSTB-5,08	Modular terminal blocks with plug entry, cross section: 0.2 - 2.5 mm ² , AWG: 26 - 12, width: 5.1 mm, color: gray
3002102	UK 3-MVSTB-5,08-LA 24RD	Modular terminal block with plug entry, nominal current: 12 A, rated voltage: 320 V, pitch: 5.08 mm, no. of positions: 1, mounting: mounting rail, with red light indicator, voltage light indicator: 24 V AC/DC, current light indicator: 3.3 mA
3002063	UK 3-MVSTB-5,08/EK	Modular terminal blocks with plug entry, cross section: 0.2-2.5 mm ² , AWG: 26-12, width: 5.1 mm, color: blue
3002131	UK 3D-MSTBV-5,08	Modular terminal blocks with vertical plug entry, cross section: 0.2 - 2.5 mm, AWG: 30 - 12, width: 5.1 mm, color: gray
3002144	UK 3D-MSTBV-5,08-LA 24RD	Modular terminal block with vertical plug entry, color: Gray, with red light indicator, voltage light indicator: 24 V AC/DC, current light indicator: 3.3 mA
3002173	UK 3D-MSTBV-5,08/EK	Modular terminal blocks with plug entry, cross section: 0.2 - 2.5 mm ² , AWG: 30 - 12, width: 5.1 mm, color: blue
2770888	UKK 3-MSTB-5,08	Modular terminal blocks with 2 horizontal plug entries, cross section: 0.2 - 2.5 mm, AWG: 30 - 12, width: 5.1 mm, color: gray
1876615	UKK 3-MSTB-5,08-PE	Ground terminal block, with 2 horizontal plug entries, nominal current: 12 A, rated voltage: 320 V, pitch: 5.08 mm, no. of positions: 1, mounting: mounting rail.
2770846	UKK 3-MSTBVH-5,08	Modular terminal blocks with vertical and horizontal plug entry, cross section: 0.2 - 2.5 mm, AWG: 30 - 12, width: 5.1 mm, color: gray
1788208	UMSTBVK 2,5/11-G-5,08	Header, nominal current: 12 A, rated voltage: 320 V, pitch: 5.08 mm, no. of positions: 11, mounting: Mounting rail

1873016	ZFKK 1,5-MSTBV-5,08	Modular terminal blocks with plug entry, cross section: 0.2 - 1.5 mm ² , width: 5.1 mm, color: gray
---------	---------------------	--

Drawings

Dimensioned drawing

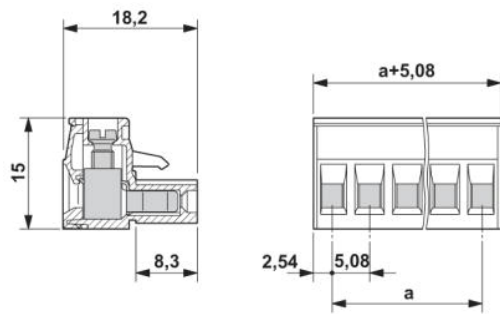

Address

PHOENIX CONTACT Inc., USA
586 Fulling Mill Road
Middletown, PA 17057, USA
Phone (800) 888-7388
Fax (717) 944-1625
<http://www.phoenixcon.com>



© 2008 Phoenix Contact
Technical modifications reserved;